

- ❖ All DC type with 「Short-circuit」 & 「Polarity reversed」 protection.
直流型都附「短路保護」及「極性保護」回路
- ❖ All AC type with 「surge absorbing circuit」 to avoid surge damage.
交流型都附「突波吸收回路」可有效防止突波破壞
- ❖ High solid compact structure 「IP-67」 suited to applied in any poor circumstance.
堅固結構「IP-67」適用各種惡劣環境
- ❖ All models with 「operating pilot.」
全機種都附「動作指示燈」

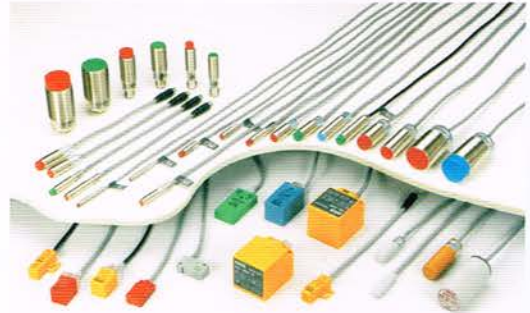

◆ Guiding of model / 型號索引

Tubular type

Ex. PM 12-04 NBS-M12
 1 2 3 4 5 6 7

- 1> Type / 型式
PM = Screw type / 螺絲型
PT = Tubular type / 圓管型
- 2> Outline diameter / 外徑
05 = M5 x 1.0 08 = M8 x 1.0 12 = M12 x 1.0
18 = M18 x 1.0 30 = M30 x 1.5
- 3> Sensing distance / 感應距離
01 = 1.0 mm 02 = 2.0 mm 04 = 4.0 mm
05 = 5.0 mm 08 = 8.0 mm 10 = 10.0 mm
15 = 15.0 mm 20 = 20.0 mm 25 = 25.0 mm
- 4> Output method / 輸出方式
N = NPN P = PNP S = SCR
- 5> Output status / 輸出狀態
Non = NO type B = NC type
- 6> Length or shape or material of body / 本體
Non = Cu plated Ni / 銅鍍鎳
S = Short type / 短型
E = Body with all screw / 全牙型
K = Stainless steel / 白鐵
- 7> Connection method / 接線方式
Non = Lead wire type / 出線式
PG = M8 lead wire type / M8 接頭出線式
M12 = M12 connector type / M12 接頭式

Square type

Ex. LS - 04 NB-V-PG
 1 2 3 4 5 6

- 1> Type / 型式
SP = Plate type / 扁型
LS = Long square type / 長條型
BS = Micro switch type / 微動開關型
PS = Square type / 方型
PL = Long square type / 長方型
PP = Plate type / 扁型
- 2> Sensing distance / 感應距離
02 = 2.0 mm 04 = 4.0 mm
05 = 5.0 mm 08 = 8.0 mm
10 = 10.0 mm 15 = 15.0 mm
25 = 25.0 mm
- 3> Output method / 輸出方式
N = NPN P = PNP S = SCR
- 4> Output status / 輸出狀態
Non = NO type B = NC type
- 5> Sensing direction / 檢測方向
Non = Horizontal type / 水平式
V = Vertical type / 垂直式
- 6> Connection method / 接線方式
Non = Lead wire type / 出線式
PG = M8 lead wire type / M8 接頭出線式
M12 = M12 connector type / M12 接頭式

◆ Output circuit & connection diagram / 輸出回路及接線圖

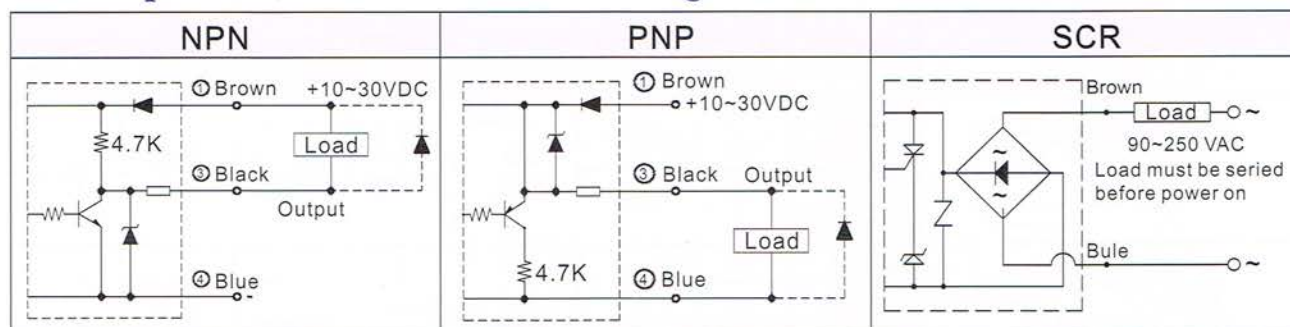

◆ General data / 共同規格

Specification		DC type	AC type
Operating voltage	工作電壓	10 ~ 30 VDC	90 ~ 250 VAC
Power ripple	電源漣波	<20% of Vp-p	50/60Hz
Output current	輸出電流	150 mA max.	100mA max.
Current consumption	消耗電流	10 mA max.	2.0mA max.
Residual voltage	殘留電壓	< 0.1V	<15V
Leakage current	洩漏電流	<0.8 mA	<4.0 mA
Hysteresis	應差	<10% of sensing distance	
Thermal drift	溫度漂移	<10 μ m/ $^{\circ}$ C	
Voltage drift	電壓漂移	<1 μ m/V	
Protection circuit	保護回路	Short-circuit & Polarity reversed	surge absorbing circuit
Operating Temperature	工作溫度	-25 $^{\circ}$ C ~ +80 $^{\circ}$ C	
Operating humidity	工作濕度	35% ~ 95% RH	
Protection class	保護等級	IP-67	
Color of sensing face	感應面顏色	NPN=Red ; PNP=Green	Blue

◆ Application hints

While a switching power supply is used, please be sure to ground the FG (Frame ground) and the G (Ground) terminal, if failure to do so, it may resulting malfunction of the sensor for the noise of the switching power supply. Meanwhile, the ripple of the DC power supply is required less than 20% to avoid resulting malfunction of the sensor.

◆ M8 lead wire connection [Available for all sensor]

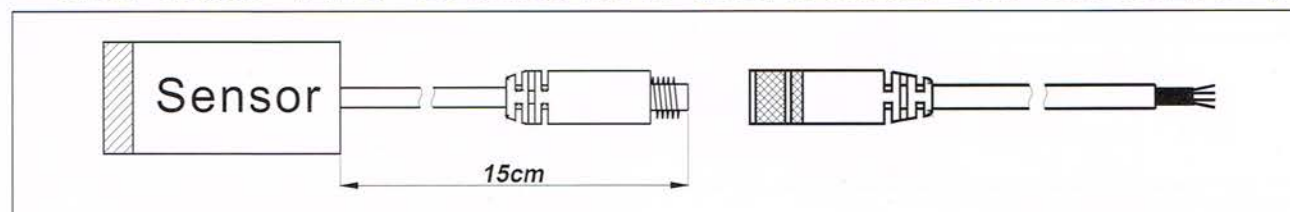

◆ **PT04 / M5 / M8 Tubular type**

Outline	Model	Output status	Output method	Sensing distance	Mounting method	Response frequency	Operating voltage	Housing material
	PT04-01N	NO	NPN	0.8 mm	Flushed	2.5KHz	10~30 VDC	SUS 304
		NO						
	PT04-01P	NO	PNP	0.8 mm	Flushed	2.5KHz	10~30 VDC	SUS 304
		NO						
	PT04-02N	NO	NPN	1.5 mm	Flushed	2.5KHz	10~30 VDC	SUS 304
		NO						
	PT04-02P	NO	PNP	1.5 mm	Flushed	2.5KHz	10~30 VDC	SUS 304
		NO						
	PM05-01N	NO	NPN	0.8 mm	Flushed	2.5KHz	10~30 VDC	SUS 304
	PM05-01NB	NC						
	PM05-01P	NO						
	PM05-01PB	NC						
	PM05-02N	NO	NPN	1.5 mm	Non-flushed	2.5KHz	10~30 VDC	SUS 304
	PM05-02NB	NC						
	PM05-02P	NO						
	PM05-02PB	NC						
	PM08-01N	NO	NPN	1.0 mm	Flushed	2.5KHz	10~30 VDC	Cu plated Ni
	PM08-01NB	NC						
	PM08-01P	NO						
	PM08-01PB	NC						
	PM08-02N	NO	NPN	2.0 mm	Non-flushed	2.5KHz	10~30 VDC	Cu plated Ni
	PM08-02NB	NC						
	PM08-02P	NO						
	PM08-02PB	NC						
	PM08-01NS	NO	NPN	1.0 mm	Flushed	2.5KHz	10~30 VDC	SUS 304
	PM08-01NSB	NC						
	PM08-01PS	NO						
	PM08-01PSB	NC						
	PM08-02NS	NO	NPN	2.0 mm	Non-flushed	2.5KHz	10~30 VDC	SUS 304
	PM08-02NSB	NC						
	PM08-02PS	NO						
	PM08-02PSB	NC						
	PM08-01N-P	NO	NPN	1.0 mm	Flushed	2.5KHz	10~30 VDC	PP
	PM08-01NB-P	NO						
	PM08-01P-P	NO						
	PM08-01PB-P	NO						
	PM08-02N-P	NO	NPN	2.0 mm	Non-flushed	2.5KHz	10~30 VDC	PP
	PM08-02NB-P	NO						
	PM08-02P-P	NO						
	PM08-02PB-P	NO						
	PM08-01N-K	NO	NPN	1.0 mm	Flushed	2.5KHz	10~30 VDC	SUS 304
	PM08-01NB-K	NC						
	PM08-01P-K	NO						
	PM08-01PB-K	NC						
	PM08-02N-K	NO	NPN	2.0 mm	Non-flushed	2.5KHz	90~250 VAC	SUS 304
	PM08-02NB-K	NC						
	PM08-02P-K	NO						
	PM08-02PB-K	NC						



◆ M12 Tubular type

Outline	Model	Output status	Output method	Sensing distance	Mounting method	Response frequency	Operating voltage	Housing material
	PM12-02N	NO	NPN	2.0 mm	Flushed	2.5KHz	10~30 VDC	Cu plated Ni
	PM12-02NB	NC						
	PM12-02P	NO	PNP					
	PM12-02PB	NC						
	PM12-02S	NO	SCR					
PM12-02SB	NC							
	PM12-04N	NO	NPN	4.0 mm	Non-flushed	2.5KHz	10~30 VDC	Cu plated Ni
	PM12-04NB	NC						
	PM12-04P	NO	PNP					
	PM12-04PB	NC						
	PM12-04S	NO	SCR					
PM12-04SB	NC							
	PM12-02NS	NO	NPN	2.0 mm	Flushed	2.5KHz	10~30 VDC	Cu plated Ni
	PM12-02NBS	NC						
	PM12-02PS	NO	PNP					
	PM12-02PBS	NC						
	PM12-04NS	NO	NPN	4.0 mm	Non-flushed	2.5KHz	10~30 VDC	Cu plated Ni
	PM12-04NBS	NC						
	PM12-04PS	NO	PNP					
	PM12-04PBS	NC						
	PM12-04N-P	NO	NPN	4.0 mm	Non-flushed	2.5KHz	10~30 VDC	PBT
	PM12-04NB-P	NC						
	PM12-04P-P	NO	PNP					
	PM12-04PB-P	NC						
	PM12-04S-P	NO	SCR					
PM12-04SB-P	NC							
	PM12-02N-E	NO	NPN	2.0 mm	Flushed	2.5KHz	10~30 VDC	Cu plated Ni
	PM12-02NB-E	NC						
	PM12-02P-E	NO	PNP					
	PM12-02PB-E	NC						
	PM12-04N-E	NO	NPN	4.0 mm	Non-flushed	2.5KHz	10~30 VDC	Cu plated Ni
	PM12-04NB-E	NC						
	PM12-04P-E	NO	PNP					
	PM12-04PB-E	NC						
	PM12-02N-M12	NO	NPN	2.0 mm	Flushed	2.5KHz	10~30 VDC	Cu plated Ni
	PM12-02NB-M12	NC						
	PM12-02P-M12	NO	PNP					
	PM12-02PB-M12	NC						
	PM12-04N-M12	NO	NPN	4.0 mm	Non-flushed	2.5KHz	10~30 VDC	Cu plated Ni
	PM12-04NB-M12	NC						
	PM12-04P-M12	NO	PNP					
	PM12-04PB-M12	NC						

◆ **M18 Tubular type**

Outline	Model	Output status	Output method	Sensing distance	Mounting method	Response frequency	Operating voltage	Housing material
	PM18-05NS	NO	NPN	5.0 mm	Flushed	800Hz	10~30 VDC	Cu plated Ni
	PM18-05NBS	NC						
	PM18-05PS	NO	PNP					
	PM18-05PBS	NC						
	PM18-08NS	NO	NPN	8.0 mm	Non-flushed	800Hz	10~30 VDC	Cu plated Ni
	PM18-08NBS	NC						
	PM18-08PS	NO	PNP					
	PM18-08PBS	NC						
	PM18-05N	NO	NPN	5.0 mm	Flushed	800Hz	10~30 VDC	Cu plated Ni
	PM18-05NB	NC						
	PM18-05P	NO	PNP					
	PM18-05PB	NC						
	PM18-05S	NO	SRC					
	PM18-05SB	NC						
	PM18-08N	NO	NPN	8.0 mm	Non-flushed	800Hz	10~30 VDC	Cu plated Ni
	PM18-08NB	NC						
	PM18-08P	NO	PNP					
	PM18-08PB	NC						
	PM18-08S	NO	SRC					
	PM18-08SB	NC						
	PM18-08N-P	NO	NPN	8.0 mm	Non-flushed	800Hz	10~30 VDC	PP
	PM18-08NB-P	NC						
	PM18-08P-P	NO	PNP					
	PM18-08PB-P	NC						
	PM18-08S-P	NO	SRC					
	PM18-08SB-P	NC						
	PM18-05N-M12	NO	NPN	5.0 mm	Flushed	800Hz	10~30 VDC	Cu plated Ni
	PM18-05NB-M12	NC						
	PM18-05P-M12	NO	PNP					
	PM18-05PB-M12	NC						
	PM18-08N-M12	NO	NPN	8.0 mm	Non-flushed	800Hz	10~30 VDC	Cu plated Ni
	PM18-08NB-M12	NC						
	PM18-08P-M12	NO	PNP					
	PM18-08PB-M12	NC						

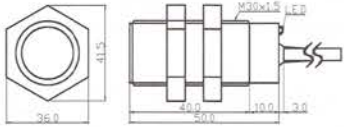
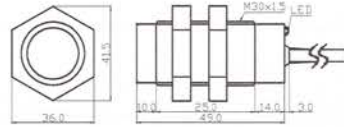
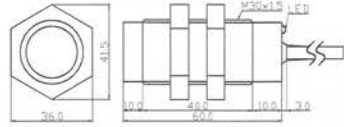
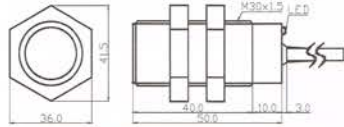
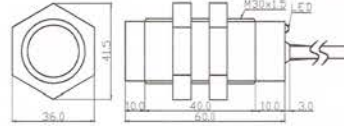
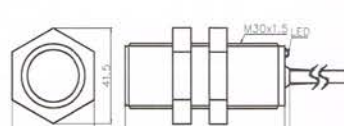
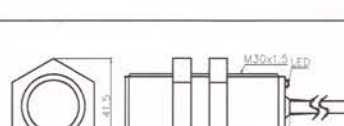
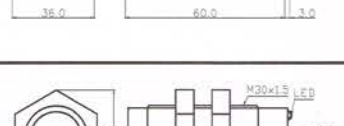
◆ M30 Tubular type

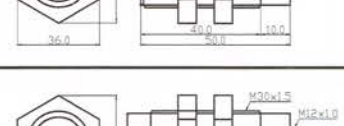
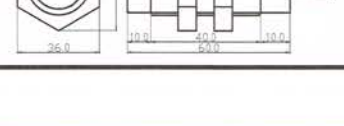
Outline	Model	Output status	Output method	Sensing distance	Mounting method	Response frequency	Operating voltage	Housing material
	PM30-10N	NO	NPN	10.0 mm	Flushed	500Hz	10~30 VDC	Cu plated Ni
	PM30-10NB	NC						
	PM30-10P	NO	PNP					
	PM30-10PB	NC						
	PM30-15N-S	NO	NPN	15.0 mm	Non-flushed	500Hz	10~30 VDC	Cu plated Ni
	PM30-15NB-S	NC						
	PM30-15P-S	NO	PNP					
	PM30-15PB-S	NC						
	PM30-15N	NO	NPN	15.0 mm	Non-flushed	500Hz	10~30 VDC	Cu plated Ni
	PM30-15NB	NC						
	PM30-15P	NO	PNP					
	PM30-15PB	NC						
	PM30-10S	NO	SCR	10.0 mm	Flushed	20Hz	90~250 VAC	Cu plated Ni
	PM30-10SB	NC	SCR					
	PM30-15S	NO	SCR	15.0 mm	Non-flushed	20Hz	90~250 VAC	Cu plated Ni
	PM30-15SB	NC	SCR					
	PM30-15N-P	NO	NPN	15.0 mm	Non-flushed	500Hz	10~30 VDC	PBT
	PM30-15NB-P	NC						
	PM30-15P-P	NO	PNP					
	PM30-15PB-P	NC						
	PM30-20N-P	NO	NPN	20.0 mm	Non-flushed	200Hz	10~30 VDC	
	PM30-20NB-P	NC						
	PM30-20P-P	NO	PNP					
	PM30-20PB-P	NC						
	PM30-15S-P	NO	SCR	15.0 mm	Non-flushed	20Hz	90~250 VAC	
	PM30-15SB-P	NC						
	PM30-20N	NO	NPN	20.0 mm	Non-flushed	200Hz	10~30 VDC	Cu plated Ni
	PM30-20NB	NC						
	PM30-20P	NO	PNP					
	PM30-20PB	NC						
	PM30-10N-M12	NO	NPN	10.0 mm	Flushed	500Hz	10~30 VDC	Cu plated Ni
	PM30-10NB-M12	NC						
	PM30-10P-M12	NO	PNP					
	PM30-10PB-M12	NC						
	PM30-15N-M12	NO	NPN	15.0 mm	Non-flushed	500Hz	10~30 VDC	Cu plated Ni
	PM30-15NB-M12	NC						
	PM30-15P-M12	NO	PNP					
	PM30-15PB-M12	NC						

◆ Connecting method of AND & OR

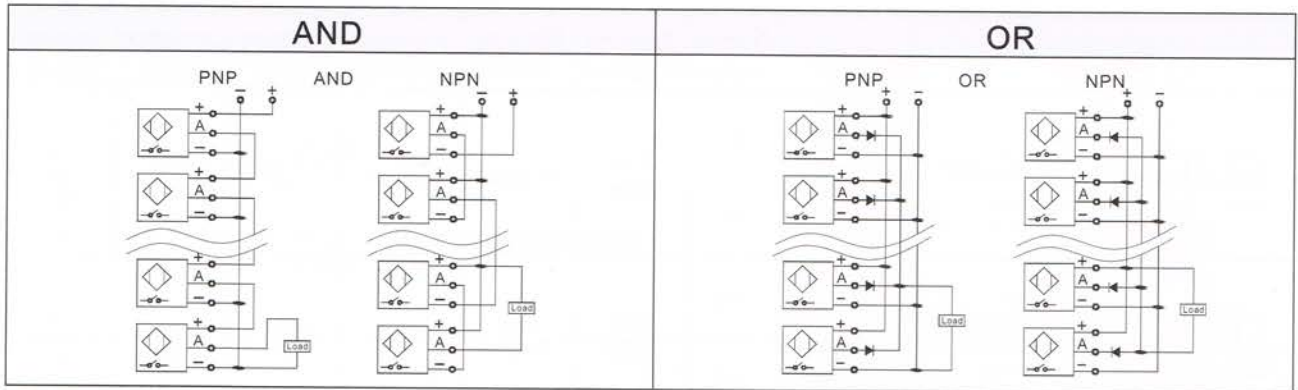

◆ Basic definition of Inductive proximity sensor / 基本定義

● Target / 標準檢測物

Which is a steel, 1mm thickness, square form with width equal to the diameter of the sensing surface, if the target is made of a different material, the sensing distance must be multiplied by the Correction factor.

標準檢測物是方型鐵片，厚度1mm，長寬等於感測器的感應面直徑。如果標準檢測物的材質不是鐵則感測距離須依右圖的修正係數修正。

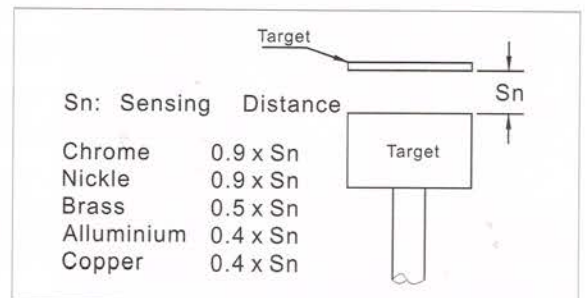

● Hysteresis / 應差

Hysteresis is the different distance between the operating points that the target is approaching and leaving the sensing area of the sensor, the value is expressed as a percentage of the sensing distance ($\Delta d/Sn\%$)

應差是感測器的動作點與復歸點的距離，一般是以動作點與復歸點的距離除以感應距離後以百分比表示。

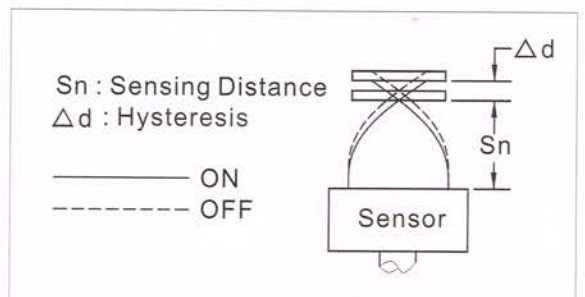

● Switch frequency / 響應頻率

It is the maximum response frequency per second, based on a pulse ratio 1 : 2, the sketch shows the condition of test.

響應頻率是以ON / OFF 比 = 1 : 2 的條件所測得每秒最高響應頻率。測試條件如右圖所示。

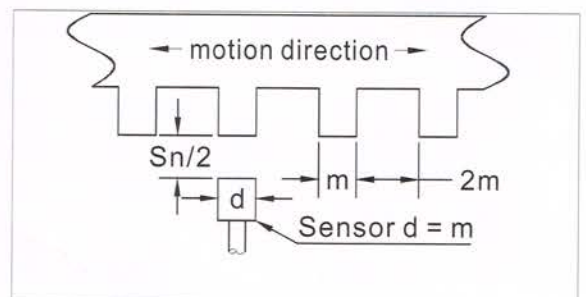

● Accuracy (Repetition) / 重複精度

Tolerance of operating position that sensor is certainly operated under the same condition.

在相同的條件下所測得的最大動作點與最小動作點的差值。

◆ Notice of installing for the Inductive proximity sensor / 安裝注意事項

● Flushed type / 埋入式

A proximity sensor can be flushed mounted in metal and surrounded by metal up to the level of the sensing face.

近接感測器可完全埋入金屬物即感應面四周可受金屬物包圍。

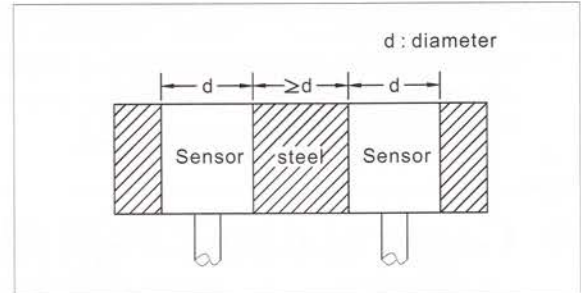

● Non-flushed / 非埋入式

A proximity sensor cannot be mounted in metal, clear zone of 3 times of the diameter of the sensing surface must be keep.

近接感測器感應面四周不可受金屬物包圍，淨空範圍必須是近接感測器感應面直徑的三倍距離以上。

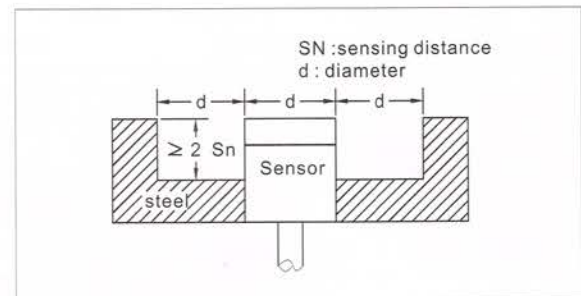

● Mutual interference / 互相干擾

To install the inductive proximity sensors of the same model by face to face or side by side, please set the minimum distance between the sensors larger than the diameter of sensor, to avoid the malfunction.

近接感測器不可以面對面或並排方式安裝，如果要以上述方式安裝務必保持近接感測器感應面直徑的一倍距離以上。

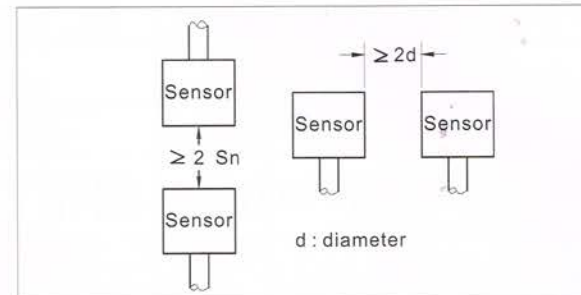

● Clamping torque / 鎖緊扭力

Be sure to set a spring washer when fixing the sensor, Don't tighten the mounting screw of PM series with a clamping torque higher than the right value.

安裝近接感測器時務必使用止滑墊圈以防止鬆脫。安裝 Pm 系列近接感測器時鎖緊扭力請勿超出最大扭力值以免損壞近接感測器。

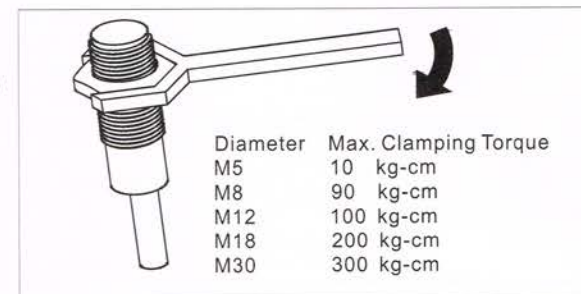

● Notice of Wiring / 配線注意事項

To avoid being influenced by noise, try best to separate the cable of the sensor from the power lines and high tension lines. if extend the sensor cable, please use a cable which diameter as same as that.

避免雜訊干擾，請儘量將感測器的電線與動力線或高壓線分離，不要綁在以起。如果要延長感測器的電線請儘量使用和感測器的電線相同規格的電線。